

Operating instructions

LEAK GUARD

BASIC

*2-channel district and local heating pipe
monitoring device*



Table of contents

Technical data	3
Ordering information	3
General information	4
Proper use	4
Safety instructions	5
Installation	6
Mounting	6
Electrical connection	6
Function/Commissioning	7
Display and control field	7
Commissioning	8
LEAKGUARD BASIC factory settings	8
LEAKGUARD BASIC function	8
Meaning of LEDs	8
Acknowledging alarm	9
Deactivating measurement for service purposes	9
Reset to factory settings	10
LEAKGUARD BASIC configuration	10
Menu	10
Measurements menu item	12
History menu item	14
Settings menu item	16
Network setting menu item	18
Reset to factory settings	19
EU Declaration of Conformity	20



Important!

All safety instructions must be read and observed before commissioning!

Technical data

LEAKGUARD BASIC

Supply voltage	90 .. 250 V AC, 50 .. 60 Hz
Power consumption	max. 5 W
Number of measurement channels	2 (e.g. for flow and return of a district heating line)
Insulation measuring range	0 .. 10 M Ω Error: 3% from measured value \pm 10 k Ω absolute
Loop measuring range	0 .. 9.99 k Ω Error: 3% from measured value \pm 0.02k Ω absolute
Measuring section	NiCr \leq 1,500 m, Nordic \leq 3,000 m
Length calculation	Yes, for NiCr
Measurement voltage	Typ. 24 V DC
Display	1 LED bar display for "ISO measured value" per measurement channel 1 LED signal for "Loop fault" per measurement channel
On-site operation	1 button each for "ISO alarm" and "Loop fault" acknowledgement 1 Ethernet interface for device configuration, limit value setting and measured value readout
Safety output contacts	1 potential-free changeover contact for: "ISO alarm" and "Loop fault" Max. switching voltage: 250 V AC, max. switching current: 1 A AC
Interfaces	Ethernet 10/100 Mbit/s, temporary for configuration
Operating temperature	-5 °C .. +40 °C
Permissible humidity	0 .. 50% at 40°C, 0 .. briefly 100% at 25°C
Housing protection class	IP 54
Application area	Indoors and protected outdoor installation according to DIN VDE 0100 Section 737 Residential and commercial areas as well as for small businesses
Housing measurements	146 x 111 x 238 mm (W x H x D)

Ordering information

2-channel district and local heating pipe monitoring device with pipe connection monitoring system, display field and signal output via potential-free contacts

LEAKGUARD BASIC (maximum length of measuring section NiCr 1,500 m)

Order no. 1089024

General

These operating instructions are intended to make it easier to familiarise yourself with the product. They contain important information on how to use the product safely, properly and economically.

The operating instructions must be supplemented with instructions based on existing national regulations for accident prevention and environmental protection.



The operating instructions must be read and followed by every person who is entrusted with working with/on the device, e.g. during installation, maintenance and troubleshooting.

In addition to the operating instructions and the binding accident prevention regulations applicable in the country of use and at the place of use, the recognised technical regulations for safe and professional work must also be observed.

Proper use

The LEAKGUARD BASIC district heating monitoring device is designed for measuring insulation and loop resistance to detect leaks in pipe systems.

For configuration, the device can be connected to a PC (laptop) via the Ethernet interface. **Integration into a network is not permitted.**

Any other use is considered improper. The manufacturer is not liable for any damage resulting from this; the risk is borne solely by the user!

Safety instructions



Important!

Safety instructions must be read and observed before commissioning!

- The operating instructions must always be available at the place of use of the product.



Accident prevention

Before assembling and disassembling the device and before opening the device housing, disconnect all areas from voltage!

- Only use the device in a technically perfect condition, as well as for its intended purpose, in a safety-conscious and risk-conscious manner and in compliance with the operating instructions.
- Do not make any changes to the device.
- Assembly, maintenance and repair work may only be carried out by trained staff.
- Only use original BRUGG spare parts.



CAUTION!

**Observe handling instructions.
Electrostatically sensitive components.**



CAUTION!

The installation location of the device should have an overall lightning protection concept which considers the power supply as well as data and telecommunication lines.



CAUTION!

Never apply external voltages to the test leads.

Installation

Mounting

The LEAKGUARD BASIC is situated in a wall-mounted housing and is attached to the wall with three screws. After assembly, the screw heads must be sealed with the enclosed rubber seals.

Detailed assembly and installation instructions can be found in the separately enclosed installation instructions of the housing manufacturer.

Electrical connection



Accident prevention

It is absolutely essential to switch off the operating voltage before working on the measurement device!

The LEAKGUARD BASIC is pre-assembled with power cable and plug and ready for connection.



CAUTION!

Both pipe connection clamps X3.3 and X4.3 must be connected to a pipe at two separate points, or one clamp must be connected to the flow pipe and one clamp to the return pipe.

Terminal assignment

X1.1 bis X1.3

ISO safety output contact

X2.1 to X2.3

Loop safety output contact

X3.1 to X3.3

Measurement loop channel 1
(a, b, pipe connection 1)

X4.1 to X4.3

Measurement loop channel 2
(a, b, pipe connection 2)

X5.1

N (neutral conductor)

X5.2

L (phase)

X6

RS232 interface (option)

X7

Ethernet interface

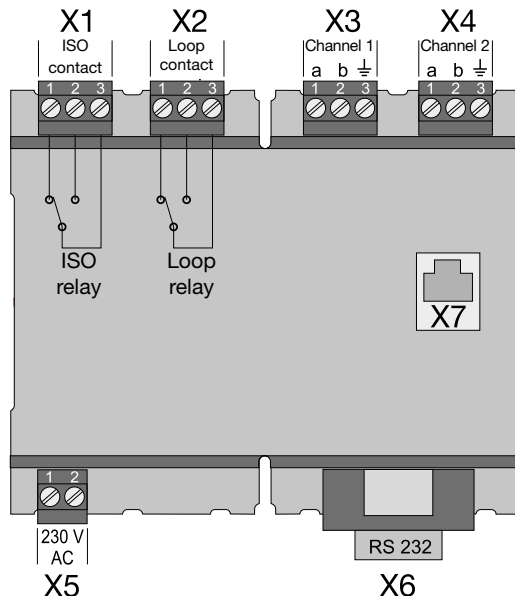

Function/Commissioning

The LEAKGUARD BASIC is a measurement and monitoring device for insulation and loop resistance for detecting leaks in pipe systems and interruptions of the measurement loop.

Each device can cyclically monitor two measurement loops, e.g. the flow and return of a district heating pipe. When exceeding or falling below the freely adjustable resistance limit values, the red alarm LEDs are activated and the corresponding alarm relay is triggered for remote alarm.

The LEAKGUARD BASIC is equipped with a pipe connection monitoring system to detect an interruption of the pipe connection (earth).

The limit values for insulation and loop resistance are freely programmable via the Ethernet interface using a laptop or netbook. All settings are stored in an internal EEPROM memory so they are protected from loss.

The LEAKGUARD BASIC can be temporarily deactivated for certain service work on the pipelines.

Display and control field

In the LEAKGUARD BASIC display and control field, you can

- Read off the values of the two insulation resistance measurement channels via the **ISO bar display LEDs**
- Read off the alarm states of the two insulation resistance measurement channels and interruptions of the pipe connection via the **ISO “error” LEDs**
- Read the alarm states of the two loop resistance measurement channels via the **Loop “error” LEDs**
- Acknowledge alarm messages of the measurement channels
- Process limit values with a laptop or notebook via the **Ethernet interface**

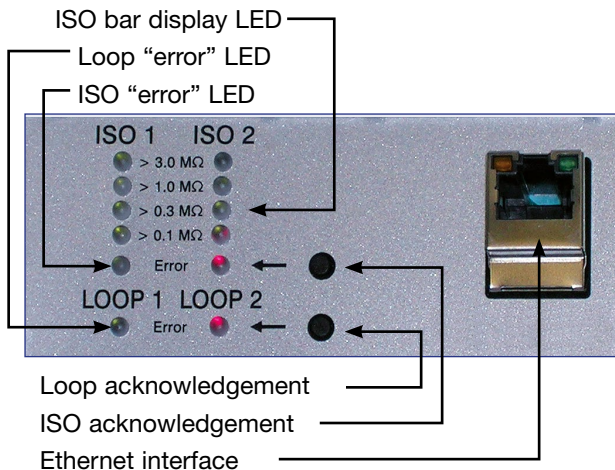

Commissioning

After switching on the supply voltage, the LEAKGUARD BASIC is initialised and runs a self-test.

All LEDs light up, then the LEDs of the bar displays go out from top to bottom.

The LEAKGUARD BASIC automatically starts continuous measurements.

The first measurement results are displayed after about 30 seconds.

If the LEAKGUARD BASIC can be operated with the factory settings, commissioning is complete.

LEAKGUARD BASIC factory settings

- Insulation resistance limit values (ISO): Alarm signal when undershooting 0,5 MΩ
- Loop resistance limit values (Loop): Alarm signal when exceeding 9 kΩ
- Measured value averaging: None
- Alarm relay: Close, relay triggers with alarm
- Alarm relay trigger delay: None

LEAKGUARD BASIC function

The LEAKGUARD BASIC measurement device works independently and must only be operated if there is an alarm.

It continuously measures the pipe connection resistance, the insulation resistance, then the loop resistance of measurement channel 1, then the same for measurement channel 2. An entire measurement cycle is completed in less than 1 minute.

Meaning of LEDs

1. The **“ISO 1” and “ISO 2” LEDs** show the range of the current measured values:
 > 0.1 | > 0.3 | >1 | > 3 MΩ.
2. The **“ISO 1” and “ISO 2” error LEDs** change from **green** to **red** when the defined limit value is undercut. They flash **alternately** if the pipe connection is interrupted. The **“ISO” alarm relay** changes its switching state to trigger the remote alarm.
3. The **“LOOP 1” and “LOOP 2” error LEDs** change from **green** to **red** when the measurement loop has been interrupted and the defined limit value has been exceeded. The **“LOOP” alarm relay** changes its switching state to trigger the remote alarm.

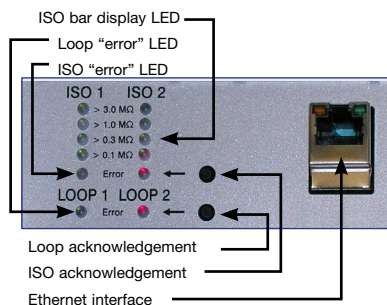

Alarm acknowledgement

To cancel remote alarms although a measured value is still in an alarm state, alarms can be acknowledged in the device.

To do so, press the acknowledgement button located to the right of the red LED. The alarm relay changes its switch status back to the idle state. The **red error LED** flashes.

The alarm acknowledgement can be cancelled by pressing the acknowledgement button again.

One acknowledgement button is responsible for both measurement channels.

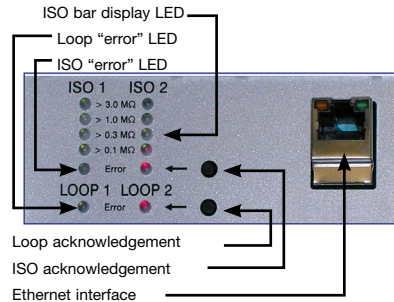

The remote alarm becomes active

- When the measured value has been within the permissible range in the meantime and then again moves outside it
- When the measured values of the other measurement channel are outside the permissible range

A fault message from the pipe connection monitoring system cannot be acknowledged as it is so serious that it must be rectified immediately.

Deactivating measurement for service purposes

If the measurements are to be deactivated for service purposes, one of the acknowledgement buttons must be pressed for at least 5 seconds. The two **green ISO "error" LEDs** flash.

Test leads a and b are then bridged internally with 10 Ω. A loop or insulation measurement can be performed from the end of the cable.

At the same time, a timer starts, which automatically reactivates the module after 12 hours.

Pressing and holding the same acknowledgement button again for at least 5 seconds reactivates the measurement.

Note:

When the measurement channel is deactivated, the measurement input is bridged with low-impedance so that the measurement loop can be measured manually at any point with "normal measurement voltage" (max. 100 V DC / 70 V AC).

Reset to factory settings

Reset to factory settings is necessary in particular if the network configuration of the LEAKGUARD BASIC has been changed in such a way that access to the configuration via the Ethernet interface (see page 10) is no longer possible.

Disconnect the network connection for this purpose!

Pressing both acknowledgement buttons simultaneously for 20 seconds until all LEDs light up briefly (see Commissioning, page 8) performs the reset.



CAUTION!

This process is irreversible.

LEAKGUARD BASIC configuration

To change the factory setting or to adjust the parameters later, a network-capable computer (laptop, notebook, netbook) with an Internet browser must be connected to the LEAKGUARD BASIC via the Ethernet interface.

Integration into a network is not permitted.

DHCP should be enabled in the network settings of the laptop used for easy access. Otherwise, the IP address of the laptop must start with 192.168.

Entering the URL "**192.168.0.2**" into the address line of the browser window calls up the LEAKGUARD BASIC start page.

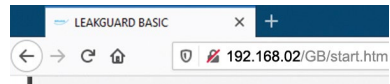

If this address cannot be called up, a reset of the LEAKGUARD BASIC can help (see page 10).

The **Overview** start page appears.

Menu

The following menu appears in the left menu bar:

- **Overview** General information on the LEAKGUARD BASIC.
- **Measurements** Display of the measured values for both measurement channels
 Display of the relay states
 Manual measured value storage
 Circuit diagram for pin connection
- **History** Table of the daily and manually stored measured values
 Graphic measured value progression curve
- **Settings** Configuration of limit values and relay states
 Deactivation of a measurement channel
 Display of the software version with revision status
- **Network settings** Configuration for network settings, access is password-protected

LEAKGUARD BASIC

192.168.02/GB/start.htm

BRUGG Pipes

BRUGG
 Pipes
 LEAKGUARD BASIC

- Overview
- Measurements
- History
- Settings
- Network Configuration

LEAKGUARD BASIC

The LEAKGUARD BASIC of Brugg is the compact and cost-effective monitoring device for district heating pipes as well as cooling pipes with surveillance pair inside their insulation layer.

Brugg Rohrsystem AG
 Industriestrasse 39
 5314 Kleindöttingen
 Schweiz
 Phone: +41 56 268 78 78

pipes@brugg.com
 www.bruggpipes.com

Copyright © 01/2021 Brugg Rohrsystem AG

Measurements menu item

1. Display of the exact **measured values** for the insulation and loop resistances of both measuring channels
Measured values within the limits are highlighted in **green**.
Measured values outside of the limits are highlighted in **red**.
 2. Display of the **switching states of the alarm relay**.
Relays not contained in the alarm are highlighted in **green**.
Relays contained in the alarm are highlighted in **red**.
 3. **Length display** of the measuring section in m in the **NiCr system**
 4. **“Save to history”** button.
Clicking this button adds the currently displayed measured value data set to the "History" table.
Adding this measured value data set does NOT interrupt the normal 24-hour measuring rhythm! The measured value data set is inserted in addition to the automatically measured values. In the measured value table (“History” menu item), it is marked with "Manual" in the last "Status" column.
 5. **Circuit diagram** for pin connection
-

LEAKGUARD BASIC

192.168.0.2/DE/measurements.htm

110%



LEAKGUARD BASIC



Overview

Measurements

History

Settings

Network Configuration

LEAKGUARD BASIC

Measurement Values

	Channel 1	Channel 2	Alarm Relay
Iso	4.66 MOhm	10.00 MOhm	open
Loop	0.15 kOhm	8.21 kOhm	open
Length NiCr	26 m	1416 m	

Save to history
Refresh

Electrical connection

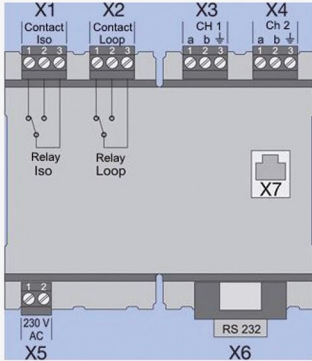

The diagram illustrates the electrical connection of the device. It shows terminals X1 (Contact Iso), X2 (Contact Loop), X3 (CH 1), and X4 (Ch 2) at the top. Below these are two relay units: 'Relay Iso' and 'Relay Loop'. A central terminal block X7 is also shown. At the bottom, there are terminals X5 (230 V AC) and X6 (RS 232).

Brugg Rohrsystem AG
 Industriestrasse 39
 5314 Kleindöttingen
 Schweiz
 Phone: +41 56 268 78 78

pipes@brugg.com

www.bruggpipes.com

History menu item

The LEAKGUARD BASIC stores the current measured values once a day, 24 hours after the last measurement.

The list contains a maximum of 30 entries, with the most recent entry at the top. If the number of entries exceeds the maximum of 30, the oldest entry is overwritten.

Measured values **shown in red** indicate an alarm status.

The status of the measurement is displayed in the last column of the table:

Clear = No measured value available. The “Clear history” button below the table has been pressed.

Reset = This is the first measured value after a restart, power failure or other technical fault. The duration of a failure is not documented.

Auto = Automatically recorded measured value in 24h rhythm.

Manual = This measurement was triggered manually in the “Measurements” menu item. The measured value is outside the 24h rhythm.

LEAKGUARD BASIC History

Channel	Loop Ch1	Iso Ch2	Loop Ch2	Status	
Channel 1 Iso					
Channel 1 Loop	1.15 kOhm	10.00 MOhm	8.21 kOhm	Manual	
Channel 2 Iso	1.15 kOhm	10.00 MOhm	8.21 kOhm	Manual	
Channel 2 Loop	1.15 kOhm	10.00 MOhm	8.21 kOhm	Manual	
5.	4.66 MOhm	0.15 kOhm	10.00 MOhm	8.21 kOhm	Manual
6.	4.66 MOhm	0.15 kOhm	0.01 MOhm	8.21 kOhm	Manual
7.	4.66 MOhm	0.15 kOhm	0.01 MOhm	8.21 kOhm	Manual
8.	4.66 MOhm	0.15 kOhm	0.01 MOhm	8.21 kOhm	Manual
9.	4.66 MOhm	0.15 kOhm	0.01 MOhm	8.21 kOhm	Manual
10.	4.66 MOhm	0.15 kOhm	0.10 MOhm	8.21 kOhm	Manual
11.	4.66 MOhm	0.15 kOhm	0.80 MOhm	8.20 kOhm	Manual
12.	4.66 MOhm	0.15 kOhm	2.00 MOhm	8.21 kOhm	Manual
13.	4.66 MOhm	0.15 kOhm	4.02 MOhm	8.21 kOhm	Manual
14.	4.66 MOhm	0.15 kOhm	5.67 MOhm	8.20 kOhm	Manual
15.	4.66 MOhm	0.15 kOhm	7.35 MOhm	8.21 kOhm	Manual
16.	4.66 MOhm	0.15 kOhm	8.02 MOhm	8.21 kOhm	Manual
17.	4.66 MOhm	0.15 kOhm	8.72 MOhm	8.21 kOhm	Manual
18.	4.66 MOhm	0.15 kOhm	9.23 MOhm	8.20 kOhm	Manual
19.	4.66 MOhm	0.15 kOhm	10.00 MOhm	8.21 kOhm	Manual
20.	4.66 MOhm	0.15 kOhm	10.00 MOhm	8.21 kOhm	Manual
21.	4.66 MOhm	0.15 kOhm	10.00 MOhm	8.21 kOhm	Manual
22.	4.66 MOhm	0.15 kOhm	10.00 MOhm	8.21 kOhm	Manual
23.	4.66 MOhm	0.15 kOhm	10.00 MOhm	8.21 kOhm	Manual
24.	4.66 MOhm	0.15 kOhm	10.00 MOhm	8.21 kOhm	Manual
25.	4.66 MOhm	0.15 kOhm	10.00 MOhm	8.21 kOhm	Manual
26.	4.66 MOhm	0.15 kOhm	10.00 MOhm	8.21 kOhm	Manual
27.	4.66 MOhm	0.15 kOhm	10.00 MOhm	8.21 kOhm	Manual
28.	4.66 MOhm	0.15 kOhm	10.00 MOhm	8.21 kOhm	Manual
29.	4.66 MOhm	0.15 kOhm	10.00 MOhm	8.21 kOhm	Manual
30.	4.66 MOhm	0.15 kOhm	10.00 MOhm	8.21 kOhm	Manual

Brugg Rohrsystem AG
Industriestrasse 39
5314 Kleindöttingen
Schweiz
Phone: +41 56 268 78 78

pipes@brugg.com
www.bruggpipes.com

In addition to the tabular display of the stored measured values, a graphical display, separated by measurement channels, is also possible.

The "Graphic" button above the table must be pressed and the desired measurement channel selected for this purpose. Clicking the "Table" button causes the display to return to tabular view.

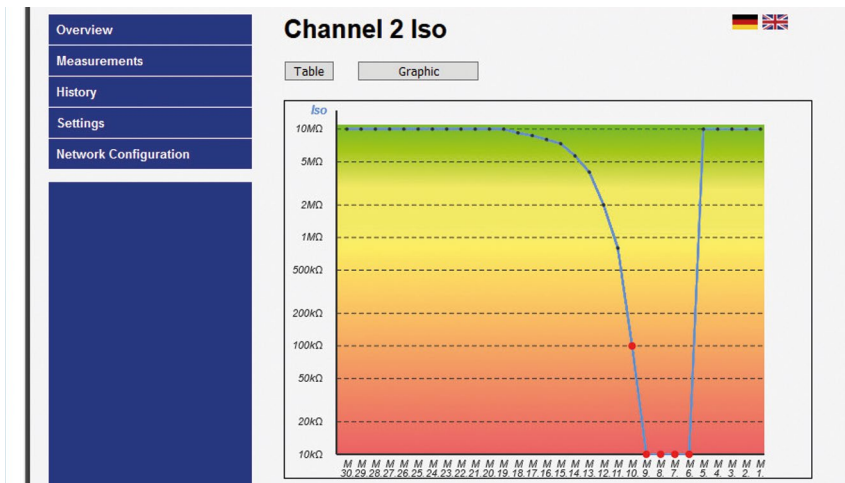

ISO measured value curve in MΩ

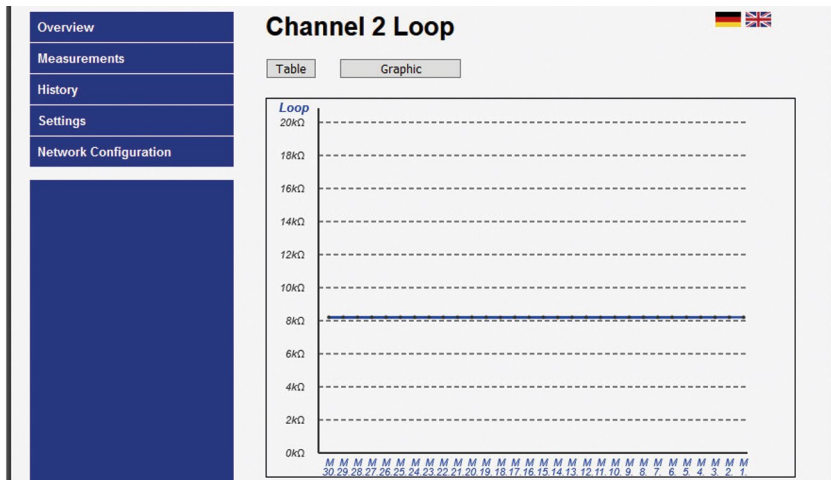

Loop measured value in kΩ

The oldest measured value is on the left, the youngest (1.) on the right.

Red measured value points • have an alarm status

Status identification below the ordinal number of the measured value:

A = Auto

M = Manual

R = Reset

Deleted (cleared) entries are not displayed.

Settings menu item

1. Display of the **software version** with revision status
2. Definition of **limit values** and **measurement channel activation**.
The permissible values are indicated behind the entry fields.

Values of measurement channels 1 and 2

- **Deactivate:** Checkbox for deactivating a measurement channel.
Empty checkbox = The measurement channel is **active**.
If, for example, only 1 measuring section is connected or a measuring section is to be deactivated for maintenance reasons, this can be entered by checking the checkbox.
Only 1 measurement channel can be deactivated.
- **ISO alarm value:** Entry of the insulation resistance limit value below which the alarm is triggered. **(Decimal commas must be entered as full stops!** Example: 1.00 M Ω)
- **ISO filter value:** Entry of the number of insulation resistance measurements from which an average value is to be calculated.
The formation of an average value prevents the alarm from being triggered by isolated incorrect measurements.
Permissible: 1 .. 16
- **Loop alarm value:** Entry of the insulation loop limit value above which the alarm is triggered.
(Decimal commas must be entered as full stops! Example: 5.00 k Ω)
- **Loop filter value:** Entry of the number of loop resistance measurements from which an average value is to be calculated.
The formation of an average value prevents the alarm from being triggered by isolated incorrect measurements.
Permissible: 1 .. 16

Alarm relay settings

- **ISO relay:** Entry of the alarm position of the insulation alarm relay.
Permissible: 0 = close (relay triggers with alarm),
 1 = open (relay deactivates with alarm)
- **Loop relay:** Entry of the alarm position of the loop alarm relay.
Permissible: 0 = close (relay triggers with alarm),
 1 = open (relay deactivates with alarm)

- **ISO alarm delay:** Enter the time delay that the loop resistance alarm relay waits until it triggers.
The setting of a time delay prevents the alarm from being triggered by brief incorrect measurements.
Permissible: 0...999 min.
- **Loop alarm delay:** Enter the time delay that the isolation alarm relay waits until it trips.
The setting of a time delay prevents the alarm from being triggered by brief incorrect measurements.
Permissible: 0...999 min.

The changed values must be saved by clicking the "Save settings" button.



BRUGG
 Pipes

LEAGUARD BASIC

Overview

Measurements

History

Settings

Network Configuration

LEAGUARD BASIC

Software Version: V1.01

Settings

This page allows the configuration of the module's system settings.
Enter the new settings for the module below:

Channel 1 :

Disable :

Alarm Value Iso : 0 ... 9.90 MOhm

Filter Value Iso : 1...16

Alarm Value Loop : 0 ... 9.99 kOhm

Filter Value Loop : 1...16

Channel 2 :

Disable :

Alarm Value Iso : 0 ... 9.90 MOhm

Filter Value Iso : 1...16

Alarm Value Loop : 0 ... 9.99 kOhm

Filter Value Loop : 1...16

Alarm Relay :

Relay Mode Iso : 0=close,1=open

Relay Mode Loop : 0=close,1=open

Alarm Delay Iso : 0...999 min.

Alarm Delay Loop : 0...999 min.

Brugg Rohrsystem AG
 Industriestrasse 39
 5314 Kleindöttingen
 Schweiz
 Phone: +41 56 268 78 78

pipes@brugg.com

www.bruggpipes.com

Network setting menu item

The network settings can be changed here.



Important!

Network settings should only be made in close cooperation with the network administrator to avoid network errors.

Access to the network setting is password-protected.

User: http

Password: http

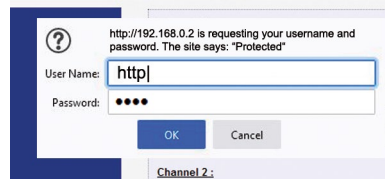

Description

- MAC address: The **MAC address** (unique product identification) of the LEAKGUARD BASIC cannot be edited.
- Host name: **Name for the LEAKGUARD BASIC** in the network can be freely edited.
- Activating DHCP server: The **Dynamic Host Configuration Protocol** checkbox (DHCP) allows assignment of the network configuration to clients by the integrated server. This setting is enabled at the factory to allow easy initial login for configuration purposes. If you are using a laptop, DHCP should be enabled in the network settings.
- IP address: **IP address for the LEAKGUARD BASIC** in the network can be freely edited. The IP address must not overlap with IP addresses already existing in the network. Factory setting: 192.168.0.2
- Gateway: The **IP address of the gateway** (access device to the network) can be freely edited.
- Subnet mask: **Subnet mask** address for the LEAKGUARD BASIC in the network can be freely edited. The **subnet mask** specifies at which bit the address must be split. The bits (network part) masked by the net mask or named by the prefix length are identical for all hosts (computers) of a sub-network.

LEAKGUARD BASIC

Overview

Measurements

History

Settings

Network Configuration

LEAKGUARD BASIC

Network Configuration

This page allows the configuration of the module's network settings.

CAUTION: Incorrect settings may cause the module to lose network connectivity.

Enter the new settings for the module below:

MAC Address:

Host Name:

Enable DHCP Server

IP Address:

Gateway:

Subnet Mask:

The changed values must be saved by clicking the "Save settings" button.

The configuration is completed, the LEAKGUARD BASIC reboots, all LEDs light up. Then the LEDs of the bar displays go out from top to bottom and the LEAKGUARD BASIC is ready for operation.

Reset to factory settings

Reset to factory settings is necessary in particular if the network configuration of the LEAKGUARD BASIC has been changed in such a way that access to the configuration via the Ethernet interface (see page 10) is no longer possible.

Disconnect the network connection for this purpose!

Pressing both acknowledgement buttons simultaneously for 20 seconds until all LEDs light up briefly (see Commissioning, page 8) performs the reset.



CAUTION!
This process is irreversible.



BRUGG

Pipes

BRUGG German Pipe GmbH

Darrweg 43
D-99734 Nordhausen

Tel. +49 (0) 36 31 462 67 0

germanpipe@brugg.com
bruggpipes.com

EU Declaration of Conformity

We declare in sole responsibility that the product

Brand: BRUGG Pipes
Type: LEAKGUARD BASIC

to which this declaration refers complies with the relevant basic health and safety provisions of the following EU directives:

2014/35/EU	Low Voltage Directive
2014/30/EU	Electromagnetic Compatibility
2011/65/EU	RoHS-II

The following standard(s) and/or technical specification(s) were used for proper implementation of the safety and health requirements specified in the EU Directives:

EN 61010-1	Safety requirements for electrical equipment for measurement, control, and laboratory use, general requirements
EN 61326-1	Electrical equipment for measurement, control and laboratory use - EMC requirements (class B)

Nordhausen, 21/9/2020

Management